



KONICA MINOLTA

SPECTRORADIOMETER CS-1000A (STANDARD MODEL) CS-1000S (SMALL MEASURING AREA MODEL) CS-1000T (SMALL MEASURING ANGLE MODEL)



Macro Lens

Small Measuring Angle Lens

Small Measuring Area Lens



Standard Lens

The essentials of imaging

Konica Minolta manufactures

reliable optical lens

via integrated

production syste



starting from R&D

and melting glass

to the final production.



High Performance Spectroradiometer

With the increased emphasis on ISO 9001, product quality has become a focal point in many companies. At the same time, in-house production departments are requiring systems that calibrate their measurement instruments. CS-1000 series Spectroradiometer supports these activities.

High-Speed

- Use of polychromator enables high-speed measurements. ↻1
- Fast measurement for the low luminance target. ↻2

↻1 Measurement speed varies depending on the luminance of the light source.

↻2 Fast Mode. Using CS-S1W

High-Accuracy

- Repeatability of 0.1%+1 digit for Luminance, 0.0002 ↻3 for Chromaticity.

↻3 Normal Mode. Using Standard Lens.

The other measurement conditions : based on Minolta standard test method.

- Measurements can be synchronized with a display device.
- Low polarization error-ideal for measuring LCD's.
- Aperture mirror eliminates misalignment between the finder target and actual measuring spot.

Low Luminance

- Specifications are guaranteed even at 1 cd/m². (Repeatability for illuminant A)
- Sensor cooling improves S/N ratio, enabling measurement of low-luminance subjects.

Display Examples

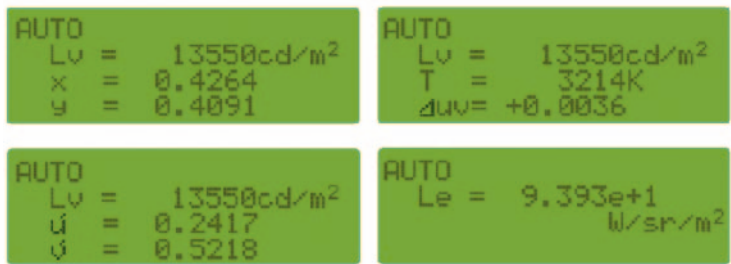

Measuring distance (from front end of the lens)	Standard Lens	Macro Lens	Small Measuring Area Lens	Small Measuring Angle Lens
25mm (At 3X zoom for Small Measuring Area model)	---	---	ø0.45mm	---
40mm (At 1X zoom for Small Measuring Area model)	---	---	ø1.1mm	---
94mm (Minimum distance for macro lens)	---	ø1.15mm	---	---
254mm (Minimum distance for Small Measuring Angle model)	---	---	---	ø1.2mm
362mm (Minimum distance for Standard model)	ø7.9mm	---	---	---
500mm	ø11.1mm	ø11.2mm	---	ø2.5mm
1000mm	ø22.3mm	ø22.4mm	---	ø5.3mm

Integral time(second)		60	30	15	1	0.5	0.1	0.04
Luminance	Standard Lens	7	14	27	409	817	4,086	10,215
(cd/m ²)	Macro Lens	70	139	278	4,174	8,348	41,742	104,355
	Small Measuring Area Lens	62	124	248	3,720	7,440	37,200	93,000
	Small Measuring Angle Lens	71	142	284	4,260	8,520	42,600	106,500

3 Different Models for the various applications

3 different optics achieved precise measurement for the various applications. Optical design technique is developed under the photographic camera engineering.

Standard Model CS-1000A

Measuring area : 1.15mm~ (with macro lens)
7.9mm~(with standard lens)
Measuring angle : 1°
Measuring distance : 94mm~ (with macro lens)
362mm~ (with standard lens)
(distance from front end the lens)

<Applications>

General application for the medium or large measuring size

- Display monitor such as LCD, CRT and OLED.
- Illumination light source and lamps.



Small Measuring Area Model CS-1000S

Measuring area : 0.45mm (by 3 times zoom)
1.10mm (by 1 time zoom)
Measuring distance : 25mm (by 3 times zoom)
40mm (by 1 time zoom)
(distance from front end the lens)

<Applications>

Very small measuring size.

- Car audio indication lamp
- Indicator panel of the vehicle



Small Measuring Angle Model CS-1000T

Measuring area : 1.2mm~
Measuring angle : 0.14° (in the minimum distance 254mm)
(Measuring angle depends on measuring distance)
Measuring distance : 254mm~ (distance from front end of the lens)

<Applications>

Device with strong directivity

- Small LCD for cellular phone



Standard Accessory

Data Processing Software CS-S1w

Data management software CS-S1w controls CS-1000 series through PC and displays measured data in numerical and graphical form. It comes with CS-1000 series as a standard accessory. It assists the measurement work with powerful functions such as user calibration, mathematical processing, interval measurement, average measurement and data transfer to the spread sheet software.

- Timed Measurements : Interval measurement, Averaged measurement
- Display : XYZ, Lvxy, Lvuv, Lv'u'v', TΔuv, Le, dominant wavelength, stimulus purity
- Display Functions : Display of spectral graph, Display of color space graph
- Calculation Functions : Mathematical operations between spectral data, Mathematical operations between spectral data and numerical values, Processing of spectral data, Computed data can be processed in the same way as measured data.
- Data Memory : Measured data : 500; Reference data : 10
- Data Output : Can be exported to Microsoft Excel and Lotus 1-2-3.

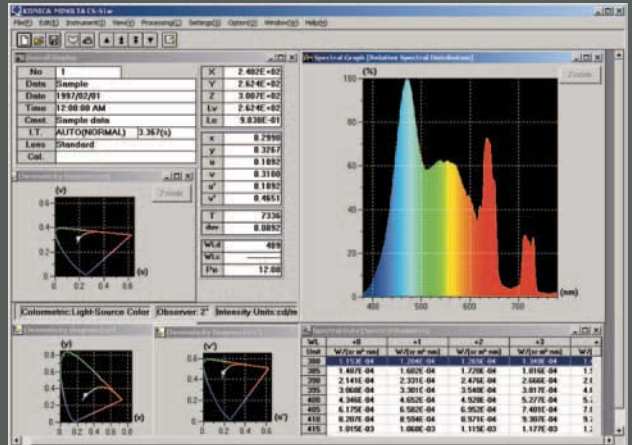

Measuring Data Display

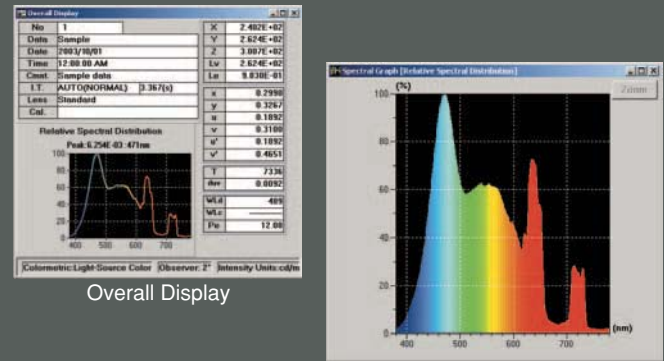

Overall Display

User-Calibration

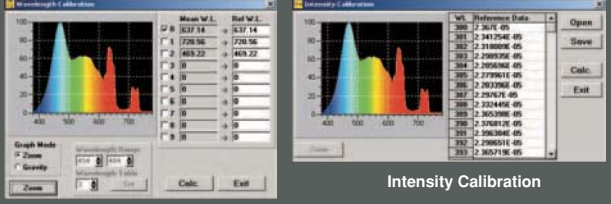

Wavelength Calibration

Intensity Calibration

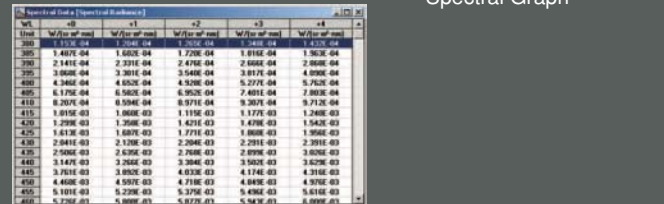

Spectral Graph

Spectral Data

Calculation

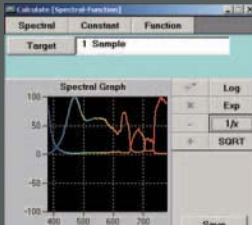

Interval Measurement

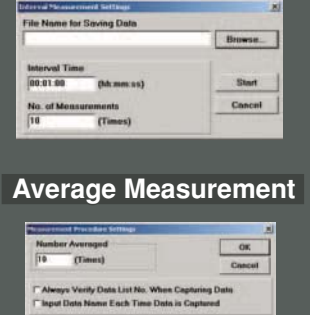

Average Measurement

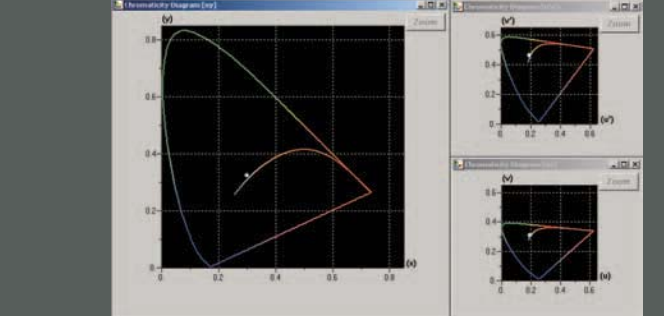

Chromaticity Diagram

Transferring data to Worksheet Programs



Colorimetric Data

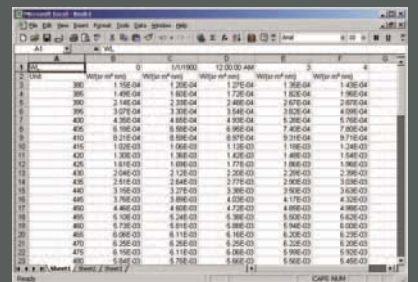

System Requirement

- PC Type : PC/AT compatible
 - CPU : Pentium 100MHz or higher
 - Memory : 16MB or more
 - CRT : 800 X 600 to 1024 X 768 resolution(recommended) (Minimum 640 X 480)
 - OS MS-DOS + Windows® 3.1 / 95 / 2000
- *Windows® is a trademark of Microsoft Corporation in the USA and other countries.

Specifications

Model	CS-1000A	CS-1000S	CS-1000T
Wavelength range	380 to 780nm		
Spectral bandwidth	5nm		
Wavelength resolution	0.9nm/pixel		
Display wavelength bandwidth	1nm		
Spectral accuracy	±0.3nm(mean wavelength:546.1nm Hg lamp)		
Acceptance angle	1° (standard and macro lens)	--- (standard lens : 1°)	0.14°*1 (standard lens : 1°)
Display	Lvxy, ΔLvxy, Lv'uV, ΔLv'uV, LvTΔuv, Le (Observer can be switched between 2° and 10°)		
Data memory	Measurement data : 30 sets, Target data : 20 sets		
Minimum measuring distance	362mm (standard lens) 94mm (macro lens)	25mm (standard lens : 362mm)	254mm (standard lens : 362mm)
Minimum measuring area	7.9mm (standard lens) 1.15mm (macro lens)	0.45mm (standard lens : 7.9mm)	1.2mm (standard lens : 7.9mm)
Luminance display range	0.01 to 80000cd/m ² (for Illuminant A)		
Accuracy (for Illuminant A, Normal Mode)	±2.5%±1digit x : ±0.0015 y : ±0.001 (standard and macro lens)	±2.5%±1digit x : ±0.002 y : ±0.0015 (small measuring area lens)	±2.5%±1digit x : ±0.002 y : ±0.0015 (small measuring angle lens)
Repeatability (σ) (for Illuminant A)	Luminance range Standard lens : 1 to 8000cd/m ² Other lens : 10 to 80000cd/m ²		Luminance range Standard lens : 1 to 8000cd/m ² Other lens : 10 to 80000cd/m ²
	Normal Mode	0.1%±1digit xy : 0.0002	
	Fast Mode	0.1%±1digit xy : 0.0004	Luminance range Standard lens : 0.5 to 1cd/m ² Other lens : 5 to 10 cd/m ²
	Normal Mode	0.1%±1digit xy : 0.0003	
Fast Mode	0.1%±1digit xy : 0.0006		
Polarisation error	Less than 5% (400nm to 780nm)		
Integration time	Fast : 40msec to 15sec, Normal : 40msec to 60sec		
Power	120V~ 50Hz Type or 230V~ 60Hz Type (using AC adapter AC-A12)		
Operating temperature /humidity range	5 to 35°C relative humidity 80% or less (at 35°C) with no condensation		
Storage temperature /humidity range	0 to 45°C relative humidity 80% or less (at 35°C) with no condensation		
Interface	RS-232C		
Size (body)	146 × 148 × 256mm (5-3/4 × 5-13/16 × 10-1/16 in.)		
Weight	4.9kg (10.38 lb.) (with standard lens)	5.8kg (12.79 lb.) (with small measuring area lens)	5.9kg (13.01 lb.) (with small measuring angle lens)
Standard accessories	Standard Lens Macro Lens	Standard Lens Small Measuring Area Lens	Standard Lens Small Measuring Angle Lens
Optional accessories	Data Processing Software CS-S1w, ND Eyepiece Filter (for finder) CS-A1, AC Adapter AC-A12, RS-232C Cable (for IBM PC/AT 2m, 9-pin) IF-A12, Tripod CS-A3, Panhead CS-A4, White Calibration Plate CS-A5, ND Filter CS-A6 (10% / for macro lens), ND Filter CS-A7 (1% / for macro lens), RS-232C Cable (for IBM PC/AT 5m pin, for IBM PS/2 2m/5m) IF-A13 to IF-A15, Hard Case CS-A2 (Not for small measuring area lens and small measuring angle lens)		

- *1 Minimum measuring distance.
- *2 Distance from front end of the lens.
- *3 Measurement time is twice integral time plus approx 3 seconds.
- Specifications subject to change without notice.
- Windows® is a trademark of Microsoft Corporation in the USA and other countries.
- Trademarks referred to are the property of their respective owners.

Enables matrix calibration of CA-210/CA-100Plus using the CS-1000A/S/T as the standard instrument.

PC Software for Color Analyzer CA-SDK

(Standard accessory of DISPLAY COLOR ANALYZER CA-210/CRT COLOR ANALYZER CA-100Plus)

Using the PC Software for Color Analyzer CA-SDK (included with the CA-210/CA-100Plus as a standard accessory), you can easily create your own special software for CA-210/CA-100Plus to meet various needs. The CA-SDK also includes some sample software. With the "Cal" sample software, you can perform matrix calibration of the CA-210/CA-100Plus using the CS-1000A/S/T as the standard instrument.

Required system
OS : Windows®98, Windows®2000, Windows®ME, Windows®XP

Windows® is a trademark of Microsoft Corporation in the USA and other countries.

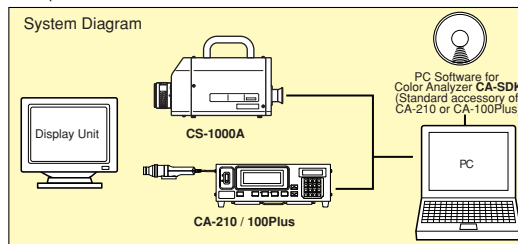

System Diagram

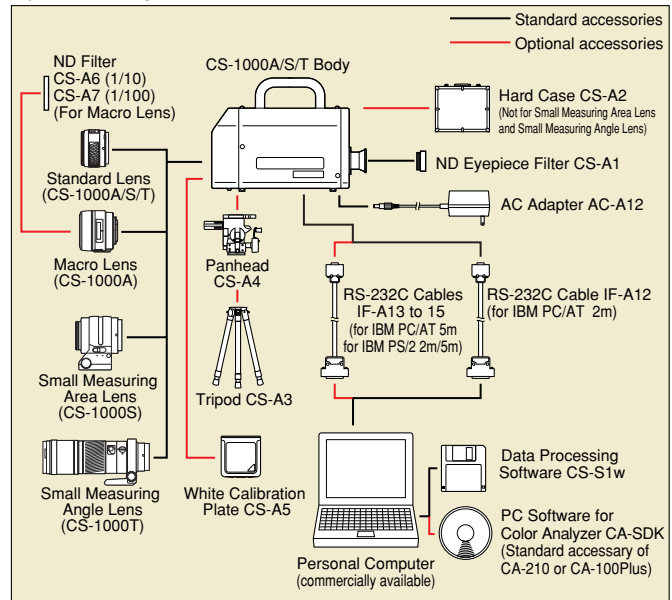

Dimensions (Units : mm)

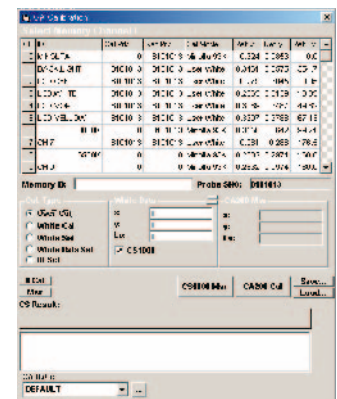
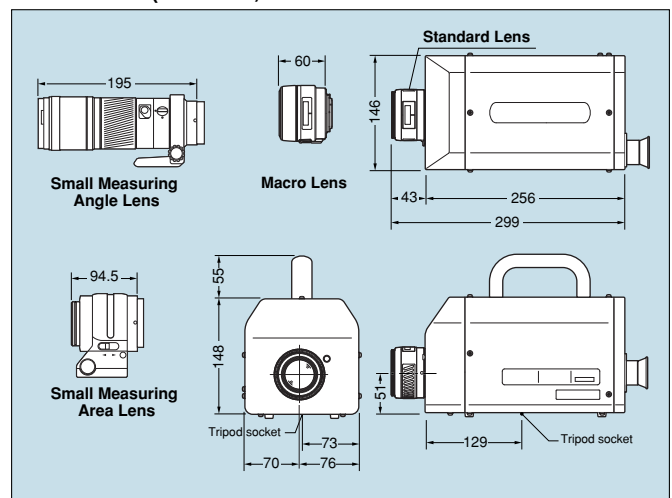

SAFETY PRECAUTIONS

To ensure correct use of the instrument, please adhere to the following.

- Before using the instrument, be sure to read the instruction manual.
- Always use the specified power. Use of inappropriate power may result in fire or electric shock.

KONICA MINOLTA SENSING, INC.

Konica Minolta Photo Imaging U.S.A., Inc.
Konica Minolta Photo Imaging Canada, Inc.
Konica Minolta Photo Imaging Europe GmbH
Konica Minolta Photo Imaging France S.A.S.
Konica Minolta Photo Imaging UK Ltd.
Konica Minolta Photo Imaging Austria GmbH
Konica Minolta Photo Imaging Benelux B.V.
Konica Minolta Photo Imaging (Schweiz)AG
Konica Minolta Business Solutions Italia S.p.A.
Konica Minolta Photo Imaging Svenska AB
Konica Minolta Photo Imaging (HK)Ltd.
Shanghai Office
Konica Minolta Photo Imaging Asia HQ Pte Ltd.
KONICA MINOLTA SENSING, INC. Seoul Office

3-91, Daisennishimachi, Sakai.Osaka 590-8551, Japan

725 Darlington Avenue, Mahwah, NJ 07430, U.S.A. Phone: 888-473-2656 (in USA), 201-529-6060 (outside USA) FAX: 201-529-6070
 1329 Meyerside Drive, Mississauga, Ontario L5T 1C9, Canada Phone: 905-670-7722 FAX: 905-795-8234
 Europaallee 17, 30855 Langenhagen, Germany Phone: 0511-740440 FAX: 0511-741050
 Paris Nord II, 385, rue de la Belle-Etoile, B.P. 50077, F-95948 Roissy C.D.G. Cedex, France Phone: 01-49386550 / 01-30866161 FAX: 01-48638069 / 01-30866280
 Precedent Drive, Rooksley Park, Milton Keynes United Kingdom Phone: 01-908200400 FAX: 01-908618662
 Amalienstrasse 59-61, 1131 Vienna, Austria Phone: 01-87882-430 FAX: 01-87882-431
 Postbus 6000, 3600 HA Maarssen, The Netherlands Phone: 030-2470860 FAX: 030-2470861
 Riedstrasse 6, 8953 Dietikon, Switzerland Phone: 01-7403727 FAX: 01-7422350
 Via Stephenson 37, 20157, Milano, Italy Phone: 02-39011-1 FAX: 02-39011-219
 Solnastrandvägen 3, P.O.Box 9058 S-17109, Solna, Sweden Phone: 08-627-7650 FAX: 08-627-7685
 Room 1818, Sun Hung Kai Centre, 30 Harbour Road, Wanchai, Hong Kong Phone: 852-34137508 FAX: 852-34137509
 Rm 1211, Ruijin Building No.205 Maoming Road (S) Shanghai 20020, China Phone: 021-64720496 FAX: 021-64720214
 10, Teban Gardens Crescent, Singapore 608923 Phone: +65 6563-5533 FAX: +65 6560-9721
 801, Chung-Jin Bldg., 475-22, BangBae-Dong, Seocho-ku, Seoul, Korea Phone: 02-523-9726 FAX: 02-523-9729