

SPECTROPHOTOMETER

CM-3600d

INSTRUCTION MANUAL

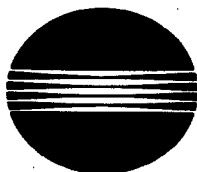



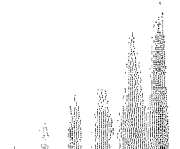







MINOLTA



⚠ SAFETY PRECAUTIONS

- To ensure correct use of this Spectrophotometer CM-3600d, read the following points carefully and adhere to them. After you have read this manual, keep it in a safe place where it can be referred to any time a question arises.

⚠ WARNING (Failure to adhere to the following points may result in death or serious injury.)	
<p> Do not use the CM-3600d in places where flammable or combustible gases (gasoline fumes, etc.) are present. Doing so may cause a fire.</p>	<p> Do not disassemble or modify the AC adapter. Doing so may cause a fire or electric shock.</p>
<p> Always use the AC adapter supplied as a standard accessory or specified replacement AC adapter with the CM-3600d, and connect it to an AC outlet (100 Vac, 50-60 Hz). Failure to do so may damage the CM-3600d or the AC adapter, causing a fire or electric shock.</p>	<p> The CM-3600d should not be operated if the CM-3600d or AC adapter is damaged, or if smoke or strange odors occur. Doing so may result in a fire. In such situations, turn the power OFF immediately, disconnect the AC adapter from the AC outlet, and contact the nearest Minolta-authorized service facility.</p>
<p> If the CM-3600d will not be used for a long time, disconnect the AC adapter from the AC outlet. Accumulated dirt or water on the prongs of the AC adapter's plug may cause a fire and should be removed.</p>	<p> Do not disassemble or modify the CM-3600d. Doing so may cause a fire or electric shock.</p>
<p> Do not insert or disconnect the AC adapter with wet hands. Doing so may cause electric shock.</p>	<p> Take special care not to allow liquid or metal objects to enter the CM-3600d. Doing so may cause a fire or electric shock. Should liquid or metal objects enter the CM-3600d, turn the power OFF immediately, disconnect the AC adapter from the AC outlet, and contact the nearest Minolta-authorized service facility.</p>

⚠ CAUTION (Failing to adhere to the following points may result in injury or damage to the CM-3600d or other property.)	
<p> Do not perform measurement with the specimen measuring port directed towards your face. Doing so may cause damage to your eyes.</p>	<p> Be careful around openings in the CM-3600d. Failure to do so may result in fingers being trapped causing injury.</p>
<p> Do not place the CM-3600d on an unstable or sloping surface. Doing so may result in its dropping or overturning, causing injury. Take care not to drop the CM-3600d when carrying it.</p>	

Notes on Use

<OPERATING ENVIRONMENT>

- The CM-3600d should be used at ambient temperatures of between 13 and 33°C (55 and 91°F). Do not use it in areas of rapid temperature change.
- Do not leave the CM-3600d in direct sunlight or near sources of heat, such as stoves etc. The internal temperature of the instrument may become much higher than the ambient temperature in such cases.
- Do not use the CM-3600d in areas where dust, cigarette smoke or chemical gases are present. Doing so may cause deterioration in performance or breakdown.
- Do not use the CM-3600d near equipment which produces a strong magnetic field (such as speakers etc.)
- The CM-3600d belongs to installation category I products (equipment which is powered by batteries or AC adapter).
- The CM-3600d belongs to pollution degree 2 products (equipment which may cause temporary electrical hazards due to contamination or condensation or products which are used in such an environment).
- Do not use the CM-3600d at altitudes of 2000m or higher.
- The CM-3600d is designed for indoor use only, and should never be used outside.

<WHITE CALIBRATION PLATE>

- The calibration data for the white calibration plate was measured at 23°C. To achieve the highest accuracy when measuring absolute values (colorimetric values), calibration and measurement should be performed at 23°C.
- Do not allow the white calibration plate to get scratched or stained.
- If you are not going to use the white calibration plate, close the lid to prevent entry of ambient light.

<TARGET MASK>

- Do not touch the inner surface (black-coated surface) of the target masks with hands, scratch or make it dirty.
- If you are not going to use the target masks, keep them in their container to prevent entry of ambient light.

<POWER SOURCE>

- Make sure that the power switch is set to OFF ("O") when the CM-3600d is not in use.
- Always use the AC adapter (AC-A12) supplied as a standard accessory and connect it to an AC outlet of the rated voltage and frequency.

<SYSTEM>

- Do not subject the CM-3600d to strong impact or vibration. Doing so may cause deterioration of performance or breakdown.
- The specimen measuring port and integrating sphere are extremely precise components, and great care should be taken to prevent them getting dirty or exposing them to impacts. When the CM-3600d is not in use, be sure to attach a target mask to the measuring port to prevent entry of foreign matter.
- The CM-3600d may cause interference if used near a television, radio, etc.
- Since the CM-3600d uses a microcomputer, external magnetic noise may cause malfunction. In this case, turn the power OFF, and wait 30 minutes, and then turn it ON again.

Notes on Storage

- The CM-3600d should be stored at temperatures of between 0 and 40°C. Do not store it in areas subject to high temperatures, high humidity, or rapid changes of temperature, or where condensation may occur. For added safety, it is recommended that it be stored with a drying agent (such as silica gel) at near room temperature.
- Do not leave or store the CM-3600d in direct sunlight, inside a closed vehicle, in the trunk of a vehicle, or in any area subject to extremely high temperatures. Doing so may cause breakdown.
- Do not store the CM-3600d in areas where dust, cigarette smoke or chemical gases are present. Doing so may cause deterioration in performance or breakdown.
- Accumulation of dust inside the integrating sphere will hinder accurate measurement. Therefore, make sure that a target mask and sample holder are attached to the CM-3600d when it is not in use.
- The white calibration plate may become discolored if left exposed to light. Therefore, make sure that the lid is closed to prevent entry of ambient light when it is not in use.
- The target masks may become discolored if they are left exposed to light. Therefore, make sure that they are kept inside their container to prevent exposure to light and to protect them from scratches and dust.
- Be sure to keep all packing materials (cardboard box, cushioning material, plastic bags, etc.). They can be used to protect the instrument during shipment to Minolta for maintenance (recalibration. etc.).

Notes on Cleaning

- If the CM-3600d becomes dirty, wipe it with a soft, clean dry cloth. Never use solvents such as thinner and benzene.
- If the white calibration becomes dirty, wipe it gently with a soft, clean dry cloth. If dirt is difficult to remove, dampen a cloth with commercially available lens cleaning liquid and wipe. Then wipe off the liquid with a cloth dampened with water, and leave it to dry.
- If the zero calibration box becomes dirty, wipe gently with a soft, clean dry cloth. If dirt is difficult to remove, dampen a cloth with commercially available lens cleaning liquid and wipe. Then wipe off the liquid with a cloth dampened with water, and leave it to dry.
- If the inner surface (black-coated surface) of the target masks or the inside of the integrating sphere get dirty, contact the nearest Minolta-authorized service facility.
- Should the CM-3600d breakdown, do not try to disassemble and repair it by yourself. Contact the nearest Minolta-authorized service facility.

CONTENTS

SAFETY PRECAUTIONS	1
WARNING	1
CAUTION	1
Notes on Use	2
<Operating Environment>	2
<White Calibration Plate>	2
<Target Mask>	2
<Power Source>	2
<System>	2
Notes on Storage	3
Notes on Cleaning	3
Introduction	6
Packing Materials	6
General Packing Materials	6
Unit Driver Floppy Disk	7
Standard Accessories	8
Optional Accessories	9
System Block Diagram	10
Names and Functions of Parts	11
Measurement Procedure	12
<Flow of Preparation and Measurement>	12
Setting the Baud Rate	13
Connecting to the Computer	14
<Notes on Connecting>	14
<Pin Assignment>	14
<Wiring Diagram>	14
<Connecting Procedure>	14
Connecting the AC Adapter	15
<Connecting Procedure>	15
Turning Power ON and OFF	16
Attaching a Target Mask	17
Attaching the Zero Calibration Box	18
Attaching the White Calibration Plate	19
<Notes on Use of White Calibration Plate>	19
Setting a Specimen	20
<Reflectance Measurements>	20
<Removing the Sample Holder>	21
<Transmittance Measurements>	22

Cleaning the CM-3600d and Accessories	23
<Zero Calibration Box and White Calibration Plate>	23
<Target Mask>	23
<Inside Integrating Sphere>	23
<Receiving Window>	24
Explanation	25
Illumination/Viewing System	26
<Measuring Reflected Colors>	26
<Measuring Transmitted Colors>	26
Illumination and Measurement Areas	27
<Target Mask>	27
<Illumination Area>	27
System Configuration	27
Overview of Simultaneous Measurement of SCI/SCE	28
Fluorescent Measurement.....	29
Dimensions	30
Specifications	31

INTRODUCTION

This spectrophotometer is designed for spectral measurement of color and color differences in various industries. It can measure both reflected and transmitted color with high accuracy.

Packing Materials

General Packing Materials

Keep all packing materials (cardboard box, cushioning material, plastic bags, etc.) in a safe place. Since the CM-3600d is a precision measuring instrument, they can be used to protect the instrument from impact and vibration during shipment to Minolta for maintenance (recalibration etc.).

Should they be lost or damaged, contact the nearest Minolta-authorized service facility.

Protective Cap for Sample Holder

The CM-3600d is delivered with no target mask attached. To protect the specimen measuring port, a protective cap is attached to the sample holder.

This protective cap must be removed before using the CM-3600d.

When you transport the CM-3600d to another place, the protective cap must be attached. Keep the protective cap in a safe place.

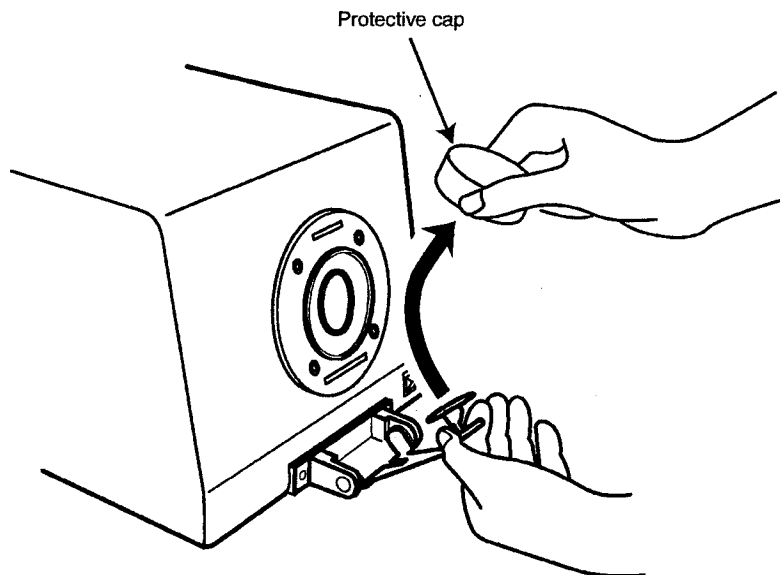

Unit Driver Floppy Disk

The unit driver floppy disk is supplied with the CM-3600d as a standard accessory.

- The unit driver disk contains data specific to your CM-3600d. If you are going to use two or more CM-3600d units, make sure that the unit driver files for the correct CM-3600d unit are used.
- Keep the unit driver disk in a safe place. If the data is lost as a result of initialization or due to damage to the disk, contact the nearest Minolta-authorized service facility.

Standard Accessories

White Calibration Plate CM-A103

Used to perform white calibration for measurement of reflectance and to perform measurement of transmittance. A floppy disk containing white calibration data and a white calibration data sheet are supplied with this accessory.

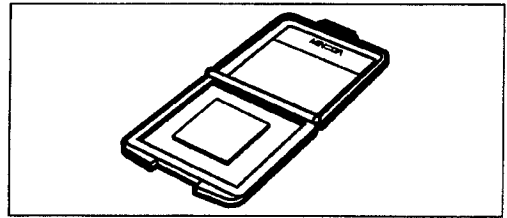

Target Mask

CM-A107 (for $\varnothing 4\text{mm}$ measurements)

CM-A106 (for $\varnothing 8\text{mm}$ measurements)

CM-A105 (for $\varnothing 25.4\text{mm}$ measurements)

Used to change the illumination area (measurement aperture) according to the specimen.

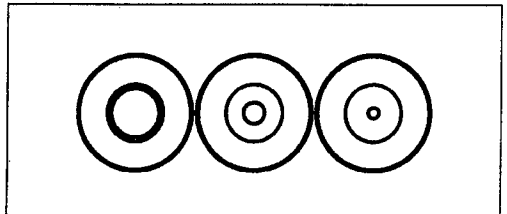

Zero Calibration Box CM-A104

Used to perform zero calibration for measurement of reflectance.

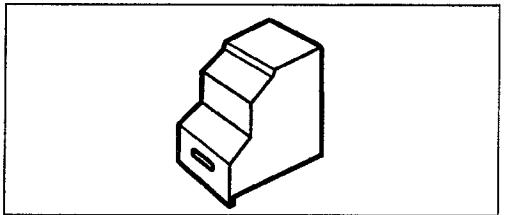

AC Adapter AC-A12

Used to supply power from an AC outlet to the CM-3600d.

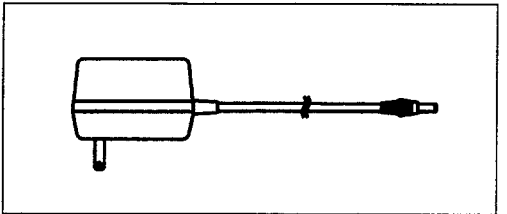

RS-232C Cable IF-A12

(for IBM PC/AT, 9-pin, 2m)

Used to connect the CM-3600d to a personal computer.

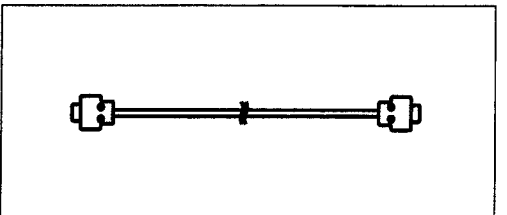

Unit Driver CM-A108

The unit driver contains instrument data.

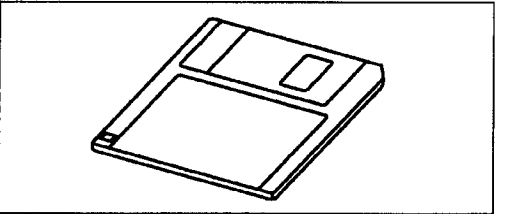

Accessory Case CM-A109

Dust Cover CM-A110

Optional Accessories

Software

SpectraMagic

This software provides various functions (e.g., data processing and file management) and allows the user to operate the CM-3600d using a personal computer.

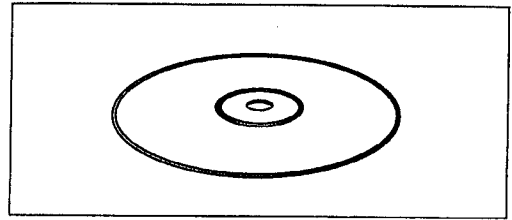

Transmittance Specimen Holder CM-A96

Used to hold the specimen for measurement of transmittance. It can hold specimens up to 22.5 mm (7/8 in.) thick.

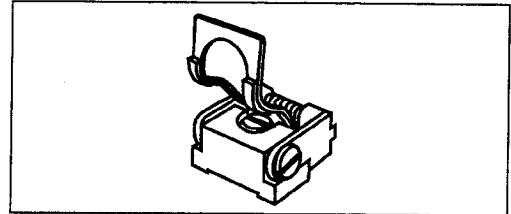

Plastic Cell

CM-A130 (optical path length 2mm)

CM-A131 (optical path length 10mm)

CM-A132 (optical path length 20mm)

This plastic container is used to hold liquid specimens.

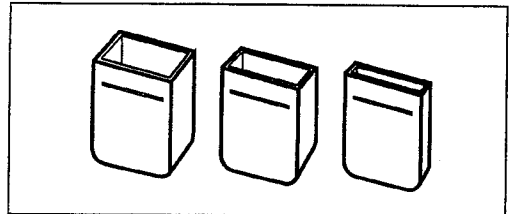

Cell

CM-A97 (optical path length 2mm)

CM-A98 (optical path length 10mm)

CM-A99 (optical path length 20mm)

This glass container is used to hold liquid specimens.

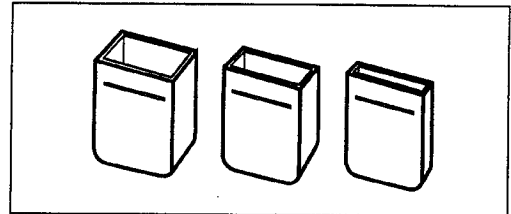

Transmittance Zero Calibration Plate CM-A100

This light blocking plate is used to perform white calibration for measurement of transmittance.

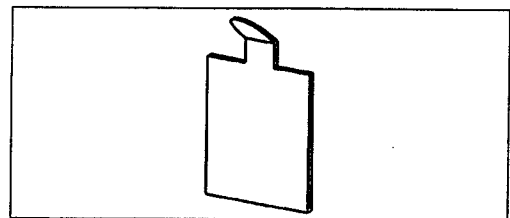

RS-232C Cable IF-A11 through IF-A15

RS-232C Cables connect the Spectrophotometer to a computer. The following types are available:

Cable	Length	Connector
RS-232C Cable IF-A11	5m/16.4 ft.	Male 25-pin D-subminiature
RS-232C Cable IF-A12	2m/6.6 ft.	Female 9-pin D-subminiature
RS-232C Cable IF-A13	5m/16.4 ft.	Female 9-pin D-subminiature
RS-232C Cable IF-A14	2m/6.6 ft.	Female 25-pin D-subminiature
RS-232C Cable IF-A15	5m/16.4 ft.	Female 25-pin D-subminiature

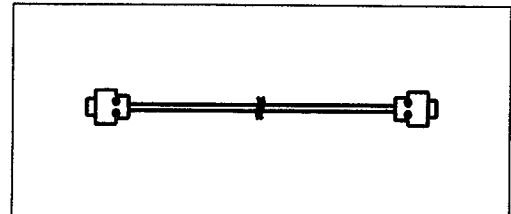

System Block Diagram

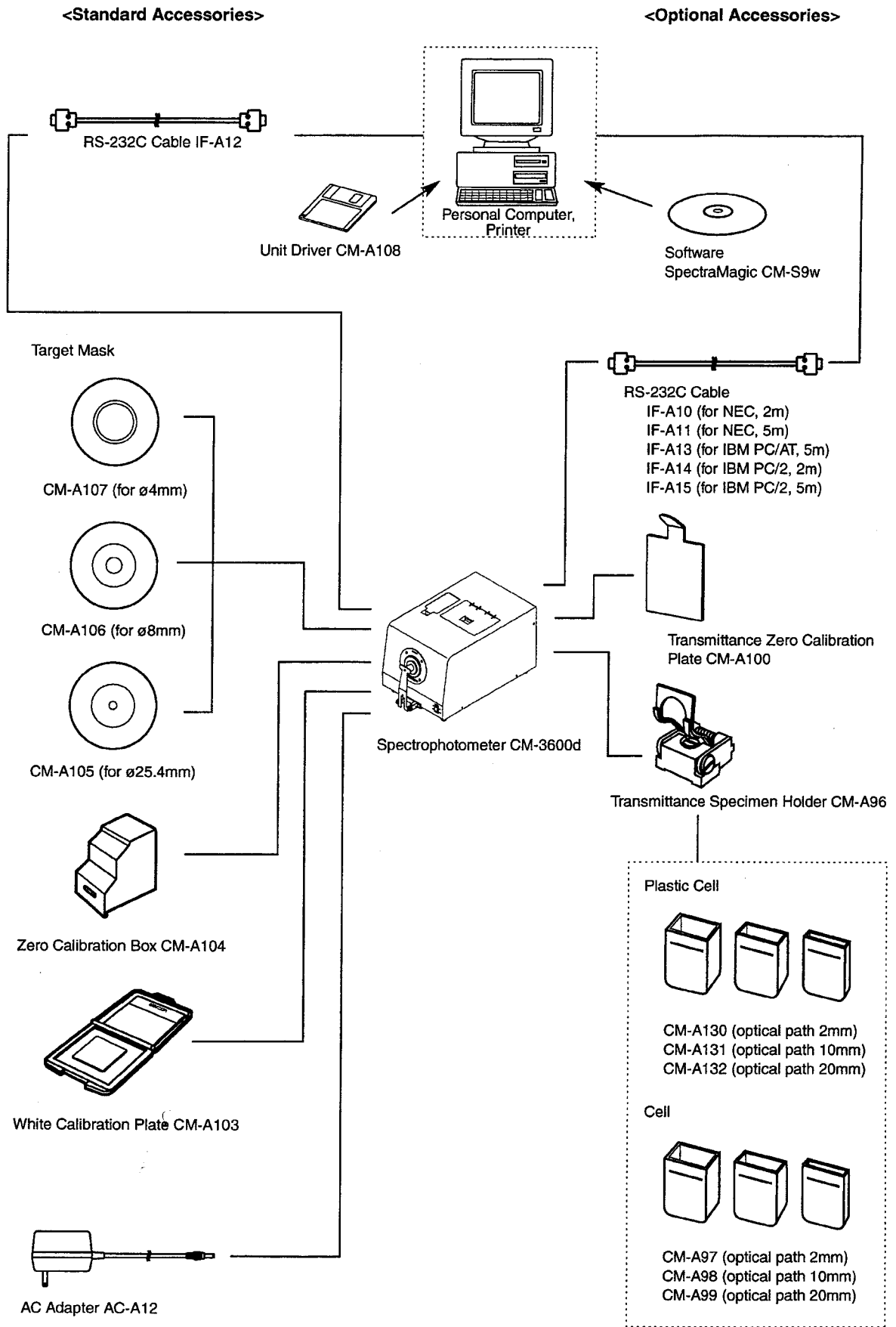

Names and Functions of Parts

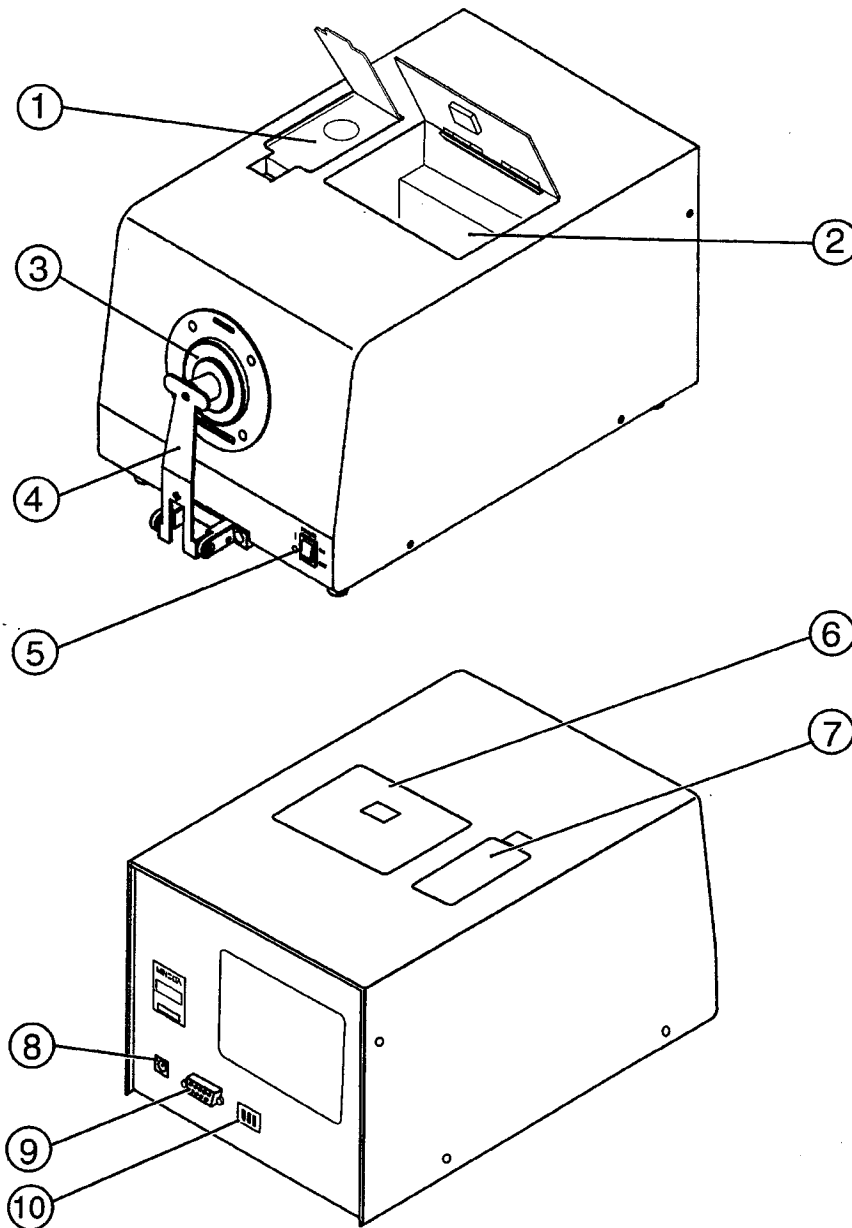

- ① Viewfinder Used to locate the position of the specimen for measurement of reflectance.
- ② Transmission chamber Place the specimen in this chamber to perform measurement of transmittance.
- ③ Target mask Select a suitable target mask (for $\varnothing 4\text{mm}$, $\varnothing 8\text{mm}$ and $\varnothing 25.4\text{mm}$ measurements) according to the specimen and attach it to the CM-3600d.
- ④ Sample holder Used to hold the specimen, white calibration plate or zero calibration box.
- ⑤ Power switch Used to turn power ON and OFF.
- ⑥ Specimen chamber cover ... Covers the specimen chamber used for transmittance measurements.
- ⑦ Viewfinder cover Open this cover to check the position of the specimen for measurement of reflectance.
- ⑧ AC adapter input socket Used to connect the AC adapter supplied with the CM-3600d.
- ⑨ RS-232C connector Used to connect the RS-232C cable supplied with the CM-3600d.
- ⑩ DIP switch Used to set communication parameters.

Measurement Procedure

- This manual explains how to prepare the CM-3600d and how to set a specimen.
- The CM-3600d is controlled by a computer to perform measurements.
- For a description of measuring method using the SpectraMagic (optional), refer to the SpectraMagic online help.

<Flow of Preparation and Measurement>

Setting the baud rate :	Set the communication parameters to communicate with the computer. (Page 13)
↓	
Connecting the computer :	Connect the CM-3600d to the computer with the RS-232C cable. (Page 14)
↓	
Connecting the AC adapter (Page 15)	
↓	
Starting the computer : (starting Windows)	Turn on the computer to be used to control the CM-3600d.
↓	
Turning the power ON (Page 16)	
↓	
Starting the software :	Starts the software set it for control of the CM-3600d.
↓	
Attaching a target mask :	Attach the target mask to be used. (Page 17)
↓	
Performing zero calibration :	Attach the zero calibration box and perform zero calibration. (Page 18)
↓	
Performing white calibration :	Attach the white calibration plate and perform white calibration. (Page 19)
↓	
Setting a specimen in place :	Set a specimen in the CM-3600d. (Page 20)
↓	
Performing measurement :	Perform measurements.
↓	
Turning the power OFF :	When measurements are complete, turn the power OFF. (Page 16)

Setting the Baud Rate

DIP switches are used to set the baud rate. Since the DIP switch settings in effect when the power is turned ON will be registered, the power must be turned OFF before setting the baud rate. If the DIP switch settings are changed while the power is ON, a malfunction may result.

	1200	2400	4800	9600	19200
Switch 1	OFF	OFF	OFF	OFF	ON
Switch 2	OFF	OFF	ON	ON	OFF
Switch 3	OFF	ON	OFF	ON	OFF

Switch 1 has been set to OFF and switches 2 and 3 to ON as the default settings before shipment of the CM-3600d. If you are going to use the optional SpectraMagic software at the software's default settings for the CM3600d make sure the DIP switches are set to the default settings.

The other communication parameters are fixed as follows.

Character bits : 8 bits
Stop bit : 1 bit
Parity check : None

Connecting to the Computer

<Notes on Connecting>

- When connecting the connectors, make sure that they are correctly oriented and secured tightly with screws.
- Before connecting, make sure that the power to the CM-3600d and host computer is turned OFF.
- When disconnecting the cable, be sure to grip the plug or connector when pulling on it. Do not pull on or forcibly bend the cable.
- Do not touch the connector terminals with your hands, allow them to get dirty or apply excessive force to them.
- Make sure that the cable has sufficient amount of slack. Stretching the cable tight may cause connection failure or wire breakage.
- When using a cable other than the one supplied as the standard accessory or one of the specified optional cables, make sure that the cable conforms to the table given below. If it does not conform, a malfunction may occur or incorrect data may be transferred between the CM-3600d and the computer.

<Pin Assignment>

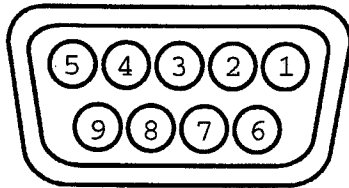

<Wiring Diagram>

CM-3600d

Personal computer
(D-sub 9-pin connector)

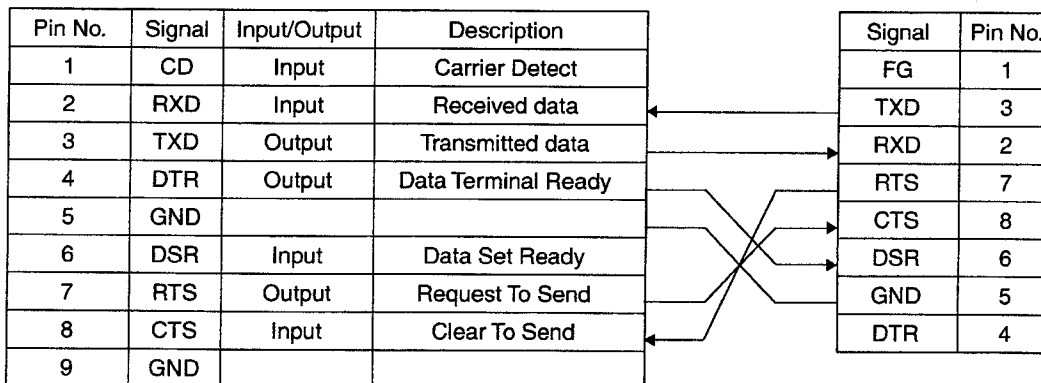

<Connecting Procedure>

1. Turn OFF the power to both the CM-3600d and the computer.
2. Connect the CM-3600d to the computer with the RS-232C cable.

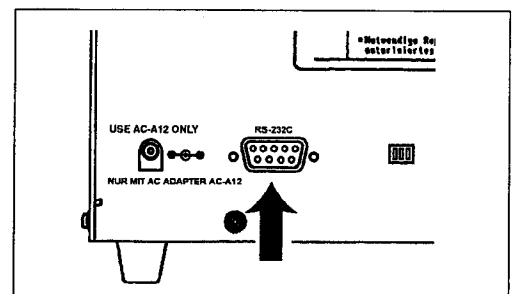

Connecting the AC Adapter

⚠ WARNING

- ❶ Always use the AC adapter supplied as a standard accessory or specified replacement AC adapter with the CM-3600d, and connect it to an AC outlet of the rated voltage and frequency. Failure to do so may damage the CM3600d or the AC adapter, causing a fire or electric shock.
- ❷ If the CM-3600d will not be used for a long time, disconnect the AC adapter from the AC outlet. Accumulated dirt or water on the prongs of the AC adapter's plug may cause a fire and should be removed.
- ❸ Do not insert or disconnect the AC adapter with wet hands. Doing so may cause electric shock.
- ❹ Do not disassemble or modify the AC adapter. Doing so may cause a fire or electric shock.

<Connecting Procedure>

1. Make sure that the power switches of both CM-3600d and host computer are set to OFF ("O").

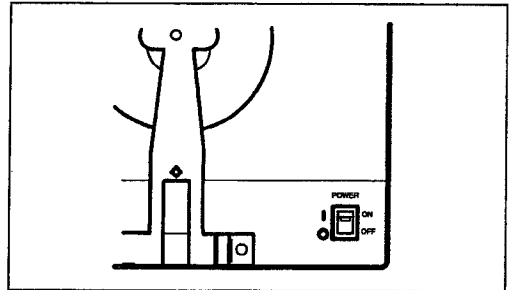

2. Insert the output plug of the AC adapter into the AC adapter input socket on the rear of the CM-3600d.

3. Insert the input plug of the AC adapter into an AC wall outlet.

- The AC Adapter AC-A12 supplied as the standard accessory must be used.
- Before disconnecting the AC adapter, the power switch must be set to OFF ("O").

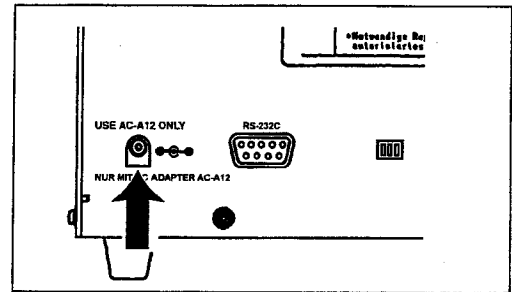

Turning Power ON and OFF

⚠ WARNING

⊘ The CM-3600d should not be operated if the CM-3600d or the AC adapter is damaged, or smoke or strange odors occur. Doing so may result in a fire. In such situations, turn the power OFF immediately, disconnect the AC adapter from the AC outlet, and contact the nearest Minolta-authorized service facility.

1. To turn the power ON, set the power switch to ON ("I").

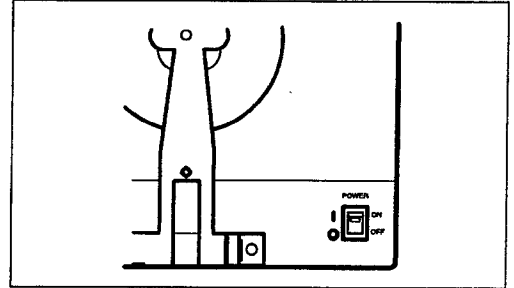

2. To turn the power OFF, set the power switch to OFF ("O").

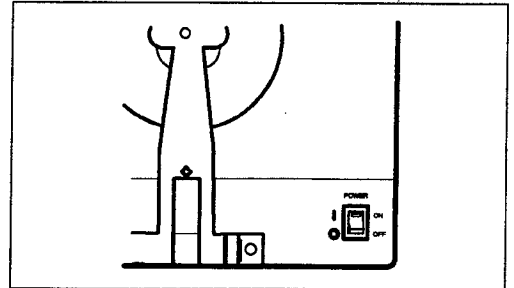

Attaching a Target Mask

⚠ CAUTION

- ⊘ Do not place the CM-3600d on an unstable or sloping surface. Doing so may result in its dropping or overturning, causing injury. Take care not to drop the CM-3600d when carrying it.
- ❗ Be careful around openings in the CM-3600d. Failure to do so may result in fingers being trapped causing injury.

The CM-3600d allows you to select a target mask from the following three types according to the specimen and your application.

Target mask

- CM-A107 (for SAV \varnothing 4mm measurements: illumination area: \varnothing 7mm)
- CM-A106 (for MAV \varnothing 8mm measurements: illumination area: \varnothing 11mm)
- CM-A105 (for LAV \varnothing 25.4mm measurements: illumination area: \varnothing 30mm)

- Take care not to scratch or make the inner surface (black-coated surface) of the target masks dirty.
- The target masks may become discolored if left in areas exposed to light. Therefore, make sure that target masks which are currently not in use are kept inside their container to prevent exposure to light.
- When not using the CM-3600d, attach one of the target masks to prevent dust entering the integrating sphere.
- If the CM-3600d is left for a long period of time with a target mask attached, the sample holder may stick to the target mask.

1. Pull the sample holder toward you and keep it open.

- The sample holder will remain open when opened more than 70 degrees.

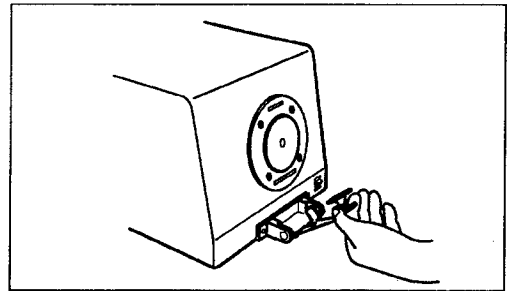

2. Remove the currently attached target mask by pulling it toward you.

- The target mask is held on by a magnet.
- Keep floppy disks away from the target mask mount area since the area is magnetized.

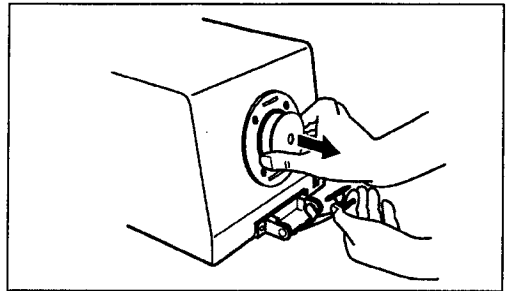

3. Take the desired target mask in your hand, and attach it to the CM-3600d. Make sure that it fits into the concave area of the integrating sphere.

- When attaching the target mask, make sure that the black-coated side faces the CM-3600d.

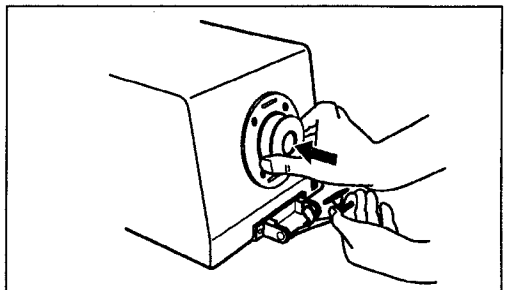

4. Release the sample holder to close it.

Attaching the Zero Calibration Box

⚠ CAUTION

● Be careful around openings in the CM-3600d. Failure to do so may result in fingers being trapped causing injury.

The zero calibration box is used to perform zero calibration for measurement of reflectance.

1. Pull the sample holder toward you and keep it open.

- The sample holder will remain open when opened more than 70 degrees.

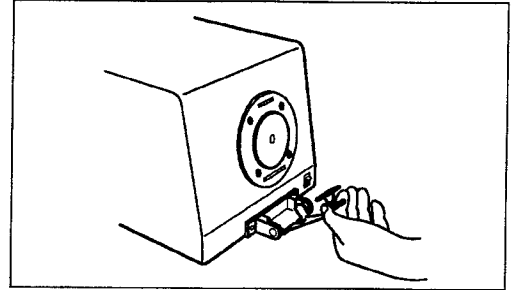

2. Fit the projections of the zero calibration box into the grooves on the CM-3600d, then close the sample holder to hold the box.

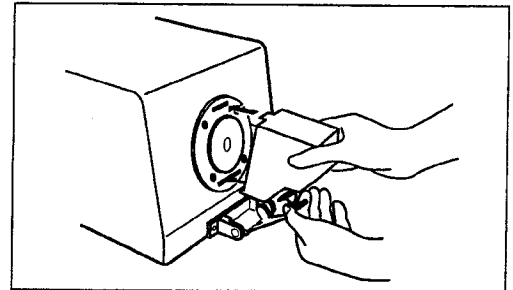

- Take care not to scratch or make the inside of the zero calibration box dirty.
- If the inside of the zero calibration box gets dirty, wipe it with a soft, clean, dry cloth.
- If dirt is difficult to remove, dampen a cloth with commercially available lens cleaning liquid and wipe the zero calibration box. Then wipe off the liquid with a cloth dampened with water, and leave the box to dry.
- Should the inside of the zero calibration box get so dirty that it cannot be cleaned, replace the box with a new one.

Attaching the White Calibration Plate

⚠ CAUTION

- ⊘ Do not perform measurement with the specimen measuring port directed towards your face. Doing so may cause damage to your eyes.
- Be careful around openings in the CM-3600d. Failure to do so may result in fingers being trapped causing injury.

The white calibration plate is used to perform white calibration for measurement of reflectance and to perform measurement of transmittance (zero calibration, 100% calibration, measurement).

1. Pull the sample holder toward you and keep it open.

- The sample holder will remain open when opened more than 70 degrees.

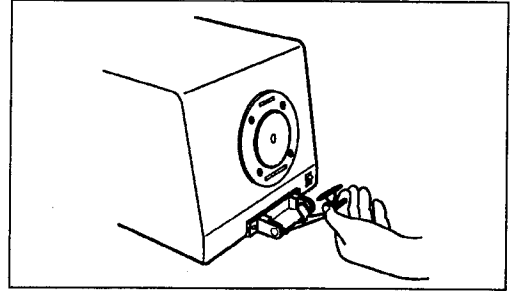

2. Hold the white calibration plate with the sample holder by fitting the sample holder into the concave (rear) side of the white calibration plate as illustrated on this page.

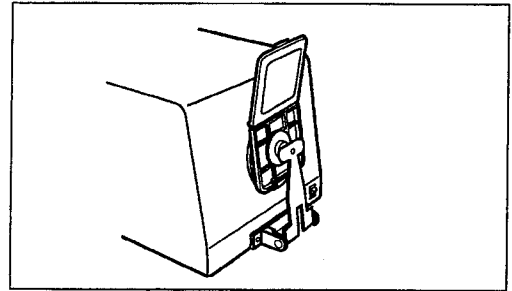

<Notes on Use of White Calibration Plate>

- The white calibration plate may become discolored if left exposed to light. Therefore, when not in use, make sure that the lid is closed to prevent exposure to light.
- Take care not to scratch or make the white calibration plate dirty.
- If the white calibration plate gets dirty, wipe it with a soft, clean, dry cloth.
- If dirt is difficult to remove, dampen a cloth with commercially available lens cleaning liquid and wipe the white calibration plate. Then wipe off the liquid with a cloth dampened with water, and leave the plate to dry.
- Should the white calibration plate get so dirty that it cannot be cleaned, replace the plate with a new one.

Setting a Specimen

⚠ WARNING

- ⊘ Do not use the CM-3600d in places where flammable or combustible gases (gasoline fumes etc.) are present. Doing so may cause a fire.
- ⊘ Do not disassemble or modify the CM-3600d. Doing so may cause a fire or electric shock.
- ⊘ The CM-3600d should not be operated if it is damaged, or smoke or odd smells occur. Doing so may result in a fire. In such situations, turn the power OFF immediately, disconnect the AC adapter from the AC outlet, and contact the nearest Minolta-authorized service facility.

⚠ CAUTION

- ⊘ Do not perform measurement with the specimen measuring port directed towards your face. Doing so may cause damage to your eyes.
- ⚠ Be careful around openings in the CM-3600d. Failure to do so may result in fingers being trapped causing injury.

<Reflectance Measurements>

To measure the reflectance of a film- or plate-like specimen, the specimen needs to be secured with the sample holder. If the specimen cannot be secured in this way, remove the sample holder and hold the specimen against the measurement aperture.

1. Pull the sample holder toward you and keep it open.

- The sample holder will remain open when it is opened more than 70 degrees.

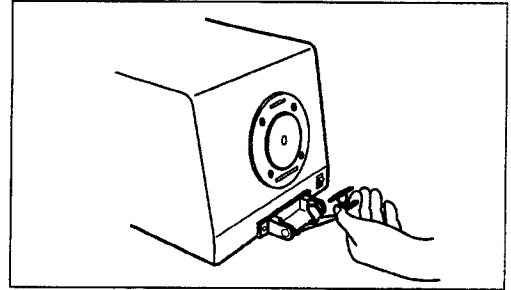

2. Secure the specimen with the sample holder.

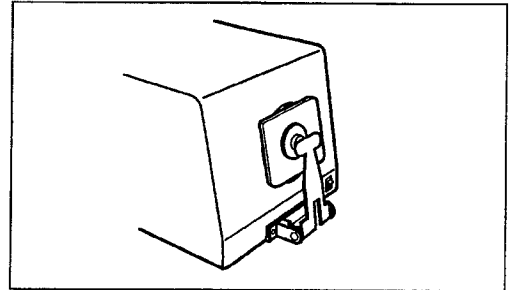

3. Open the viewfinder cover and check the measuring point.

- When checking the measuring point while you are seated, position the viewfinder cover at the desired angle so that the image reflected in the mirror inside the viewfinder cover can be observed.
 - ◆ When the viewfinder cover is opened, the specimen will be illuminated for 60 seconds by a lamp to enable you to check the measuring point.
- Do not exert excessive force on the viewfinder cover while it is open.
- It is not possible to perform measurement if the viewfinder cover is open.

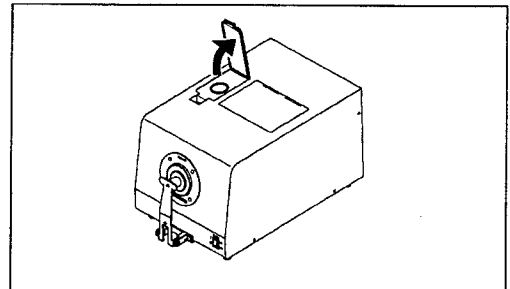

4. Adjust the position of the specimen so that the area to be measured is centered in the measurement aperture, then close the viewfinder cover.

- * When adjusting the position of the specimen, the sample holder must be pulled and kept open. This will prevent the sample holder scratching the surface of the specimen during adjustment.

<Removing the Sample Holder>

1. Use a Philips screwdriver to turn the two screws counter-clockwise to remove the sample holder.

- Keep the screws and sample holder in a safe place.

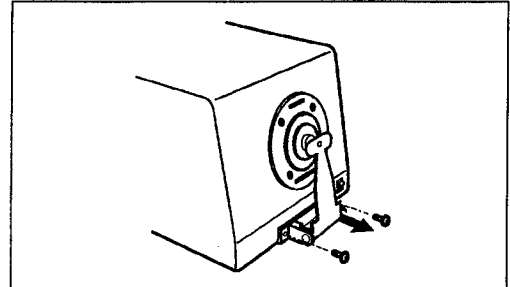

<Transmittance Measurements>

1. Open the cover of the transmission chamber.

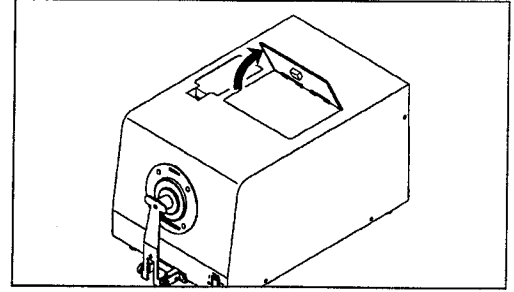

2. Place the specimen against the illumination window tightly. (When measuring a liquid specimen, the specimen container must be placed against the illumination window.)

- The specimen must be placed so that its measuring area covers the entire illumination window.
- It is recommended that the optional transmittance specimen holder CM-A96 be used to hold the specimen in place.
- In the case of a liquid specimen, use of an optional cell (CM-A97 to 99, A130 to 132) is recommended.
- If you are going to use a container other than the above cells, it must be transparent and constructed in such a way that it can be positioned with opposing surfaces parallel to both illumination and receiving windows.
- Take care not to spill the liquid specimen on the CM-3600d. Should there be any spillage, immediately wipe it with a soft, dry cloth.
- Never measure flammable liquids.
- No measurements must be performed if the specimen or its container is scratched or dirty. If you hold the measuring surface of the specimen with your fingers, it will be marked with finger prints, so always hold the other part of the specimen when setting it in place.
- Air bubbles on the inner surface of the specimen's container will hinder correct measurements, so make sure that all air bubbles are removed before measurement. (Air bubbles sometimes develop even if the container is just left standing still.)
- Correct measurements will be hindered if water drops develop on the specimen or its container due to condensation.
- Liquids containing particles may cause unstable measurements due to precipitation of the particles.

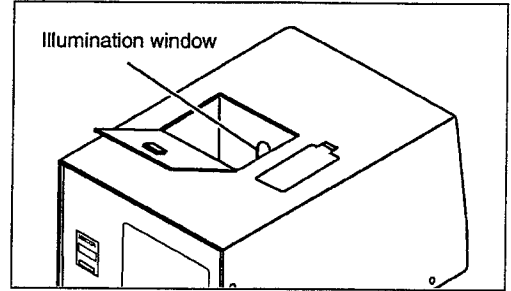

3. Close the cover of the transmission chamber.

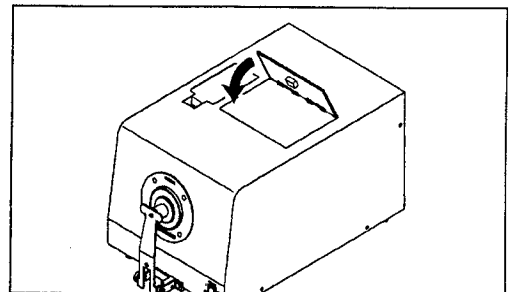

Cleaning the CM-3600d and Accessories

⚠ WARNING

- Ⓜ Do not disassemble or modify the CM-3600d or AC adapter. Doing so may cause a fire or electric shock.
- Ⓜ The CM-3600d should not be operated if it is damaged, or if smoke or strange odors occur. Doing so may result in a fire. In such situations, turn the power OFF immediately, disconnect the AC adapter from the AC outlet, and contact the nearest Minolta-authorized service facility.

⚠ CAUTION

- Ⓜ Be careful around openings in the CM-3600d. Failure to do so may result in fingers being trapped causing injury.

<Zero Calibration Box and White Calibration Plate>

Wipe gently with a dry soft cloth. If dirt is difficult to remove, dampen a cloth with commercially available lens cleaning liquid and wipe. Then wipe off the liquid with a cloth dampened with water, and leave it to dry.

- When cleaning, take care not to scratch the zero calibration box or white calibration plate.

<Target Mask>

Use a blower to remove dirt and dust from the target masks.

- Do not touch the black-coated surface of the target masks with fingers or wipe it with a cloth. If the target masks get so dirty that dirt cannot be removed using a blower, contact the nearest Minolta-authorized service facility.

<Inside Integrating Sphere>

1. Make sure that there is nothing placed against the illumination window.

2. Block the receiving window so that no dust or dirt enters.

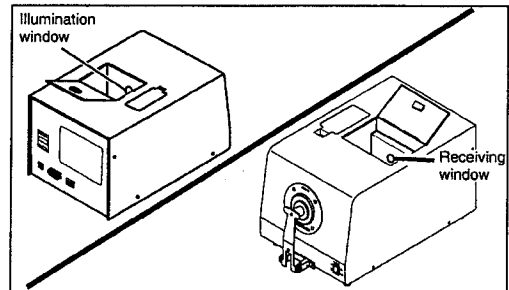

3. Open the sample holder and remove dust and dirt using a blower.

- Do not touch the white-coated inner surface of the integrating sphere, wipe it with a cloth or place any object against it. If the white-coated surface gets so dirty that dirt cannot be removed using a blower, contact the nearest Minolta-authorized service facility.

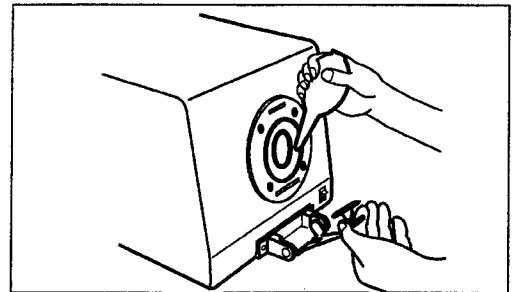

<Receiving Window>

1. Set the measurement area to SAV.

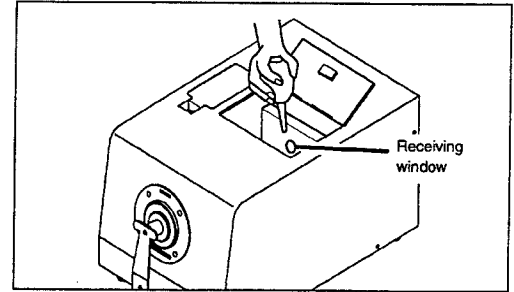

2. Use a blower to remove dirt and dust from the receiving window.

- Do not put your fingers into the receiving window or touch any optical lenses.

Explanation

Illumination/Viewing System

<Measuring Reflected Colors>

The flow of measurement is shown below.

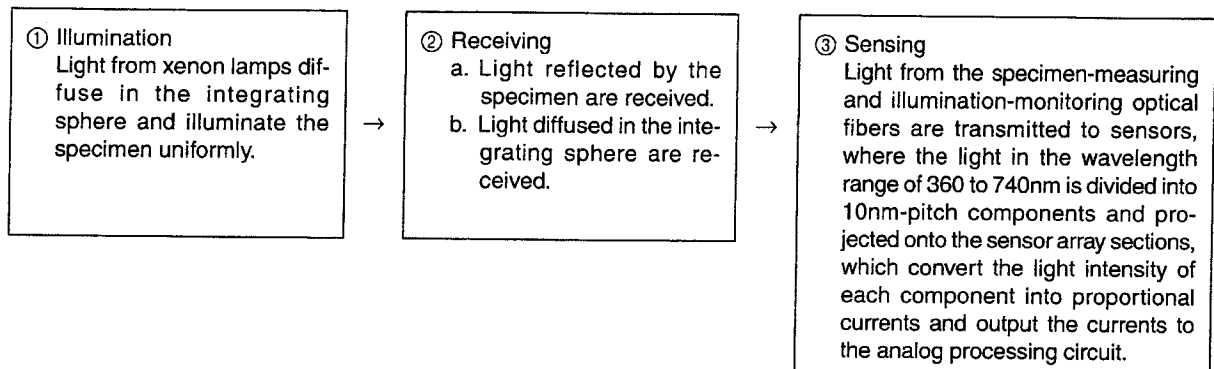

The d/8 geometry conforms to CIE No. 15, ISO 7724/1, ASTM E1164, DIN 5033 Teil 7, and JIS Z8722-1982 (diffused illumination/perpendicular viewing system) standards, and offers both SCI (specular component included) and SCE (specular component excluded) measurements.

- ① Light from the pulsed xenon lamps are diffused by reflection from the inner surface of the integrating sphere, and finally illuminate the specimen uniformly.
 - ② a. The light reflected by the specimen surface at an angle of 8° to the normal to the surface passes through the transmittance chamber and is then received by the specimen-measuring optical system and guided to the sensor.
b. The diffused light in the integrating chamber is received by the illumination-monitoring optical fiber and guided to the sensor.
 - ③ The light from the specimen-measuring optical fiber and from the illumination-monitoring optical fiber is divided into each wavelength component and projected onto the sensor array sections, which convert the light into proportional currents and output the currents to the analog processing circuit.
- By using the outputs from the specimen-measuring sensor and the illumination-monitoring sensor for calculations, compensation for slight differences in the spectral characteristics and intensity of the illumination light is performed (double-beam system).

<Measuring Transmitted Colors>

The flow of measurement is shown below.

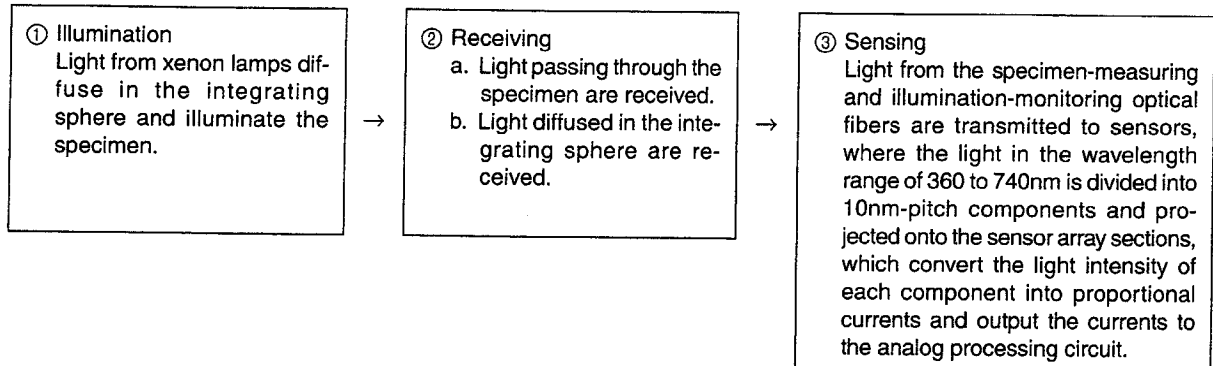

The d/0 geometry conforms to CIE No. 15, ASTM E1164, and DIN 5033 Teil 7 standards.

- ① Light from the pulsed xenon lamps are diffused by reflection from the inner surface of the integrating sphere and the surface of the white calibration plate covering the measurement aperture, and finally illuminate the specimen in the transmittance chamber.
 - ② a. The light transmitted by the specimen is received by the specimen-measuring optical system and guided to the sensor.
b. The diffused light in the integrating chamber is received by the illumination-monitoring optical fiber and guided to the sensor.
 - ③ The light from the specimen-measuring optical fiber and from the illumination-monitoring optical fiber is divided into each wavelength component and projected onto the sensor array section, which convert the light into proportional currents and output the currents to the analog processing circuit.
- By using the outputs from the specimen-measuring sensor and the illumination-monitoring sensor for calculations, compensation for slight differences in the spectral characteristics and intensity of the illumination light is performed (double-beam system).

Illumination and Measurement Areas

The CM-3600d allows you to select a target mask from the three types: SAV (for $\varnothing 4\text{mm}$ measurements), MAV (for $\varnothing 8\text{mm}$ measurements) and LAV (for $\varnothing 25.4\text{mm}$ measurements), according to the specimen and your application. Select and attach a suitable target mask (illumination area) for each measurement area.

<Target Mask>

Since the CM-3600d has no target mask detection function, it is not possible for the instrument to determine which target mask has been attached. Thus, when switching from one target mask to another, be sure that the intended target mask is attached.

Furthermore, since the target masks are coated in black and measurement is influenced by the condition of this coated surface, do not touch this surface with hands, scratch it or make it dirty.

<Measurement Area>

The illumination area is switched from one to another as the condensing lens of the receiving optical system is moved by the motor according to the commands from the personal computer.

System Configuration

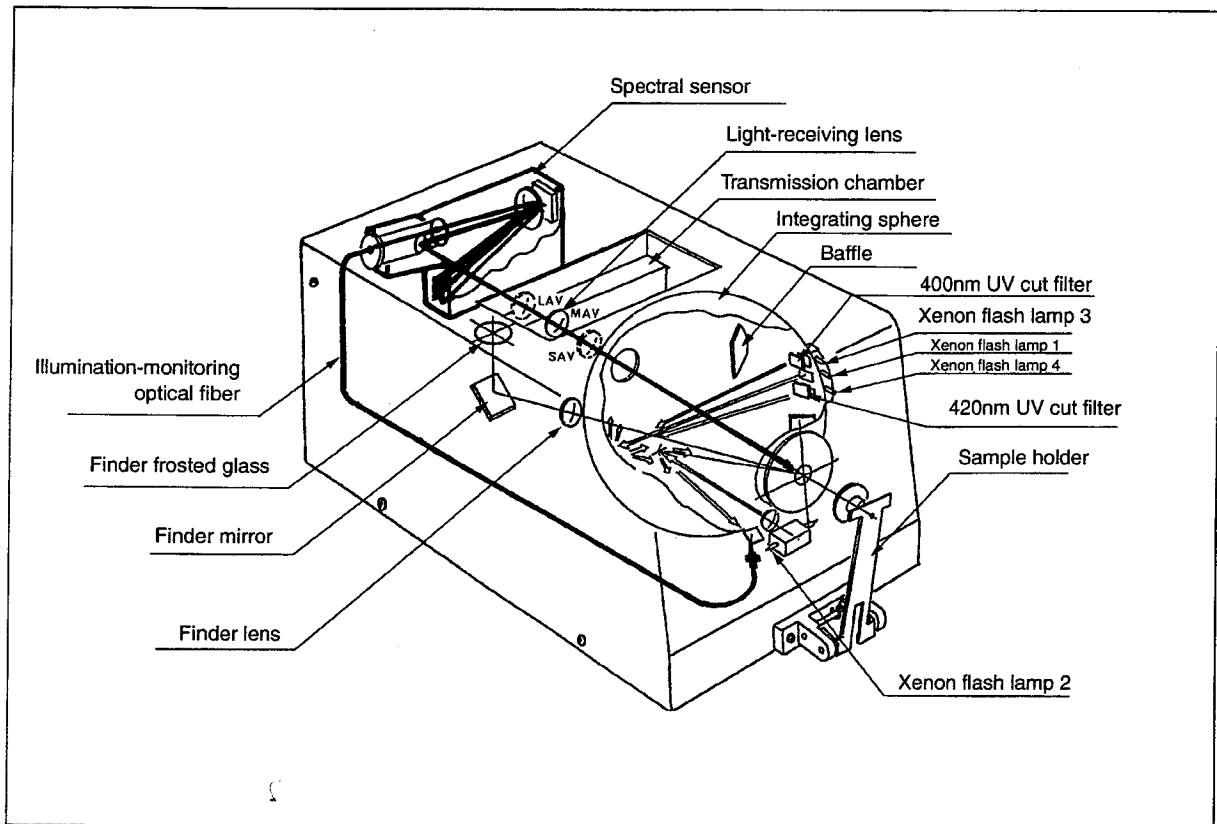

Overview of Simultaneous Measurement of SCI/SCE

The CM-3600d offers simultaneous measurement of SCI (specular component included)/SCE (specular component excluded). With conventional model, SCI and SCE are switched mechanically by opening and closing an optical trap provided inside the integrating sphere. This conventional method requires mechanical switching whenever SCI and SCE need to be switched. In addition, it is not possible to start measurement until switching is completed.

The CM-3600d has eliminated mechanical switching and enables acquisition of SCI and SCE data by performing calculations with the measured data obtained using two light sources.

SCI/SCE SIMULTANEOUS MEASUREMENT

- Light sources ① and ② are located as illustrated at right. Light source ① flashes first.
 - ◆ Light source ① is a normal diffused type, and enables the user to obtain SCI measurement data when it flashes.
- Next, light source ② flashes.
 - ◆ Light source ② enables numerical control of specular reflected lights. The data obtained when this light source flashes (i.e., the amount of light on the surface of the specimen) and the one obtained when light source ② flashes can then be used to calculate the SCE measured data.

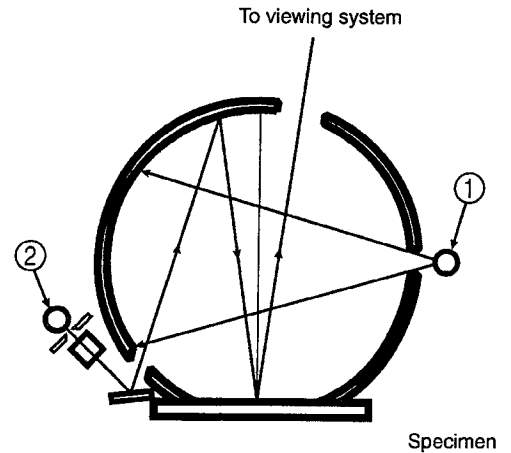

By performing the above measurement and calculation during each measurement, both SCI and SCE measurement data can be obtained simultaneously without the need for mechanical switching.

Fluorescent Measurement

The CM-3600d incorporates two types of xenon lamps as light sources for Fluorescent measurements (UV full light source and UV cut light source) and performs numeric calculation of the reflectance when the specimen is illuminated by these two light sources to obtain fluorescent reflectance.

WHEN FLUORESCENT CALIBRATION IS PERFORMED:

When SpectraMagic is used, the following four fluorescent calibration methods are available to enable accurate measurement of fluorescent reflectance.

1. Profile mode

⇒ Correction coefficients for fluorescent measurement are obtained based on the calibrated reflectance profile of the fluorescent standard plate (the reflectance profile is created by entering reflectance for each wavelength).

2. Tint mode

⇒ Correction coefficients for fluorescent measurement are obtained so that the measured CIE Tint value for the fluorescent standard plate is within the specified range (Tint value for the fluorescent standard plate calibrated with a D65 light source is entered).

3. Whiteness (WI) mode

⇒ Correction coefficients for fluorescent measurement are obtained so that the measured CIE WI (whiteness index) value for the fluorescent standard plate is within the specified range (WI value for the fluorescent standard plate calibrated with a D65 light source is entered).

4. Tint and WI mode

⇒ Correction coefficients for fluorescent measurement are obtained so that the measured CIE Tint and WI values for the fluorescent standard plate are both within the specified range (Tint and WI values for the fluorescent standard plate calibrated with a D65 light source are entered).

CALCULATING FLUORESCENT REFLECTANCE

Based on the measured reflectances for the fluorescent standard plate obtained under the UV full light source and under the UV cut light source, the amount of fluorescence is obtained. The correction coefficients for fluorescent measurement are then determined so that the given reference values are satisfied.

(Calibration example: Profile mode)

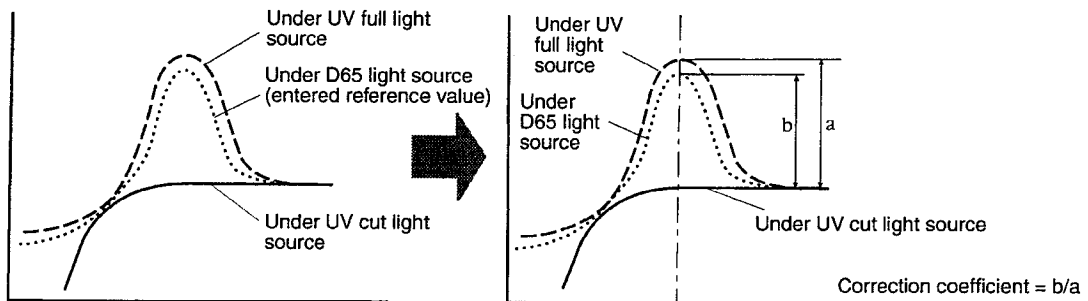

These correction coefficients are then used to obtain the fluorescent reflectance by performing numeric calculations using the measured reflectances under the UV full light source and under the UV cut light source.

As a result, the CM-3600d can keep the fluorescent output quantity as close to the standard as possible, without the need for adjusting the quantity of ultraviolet light, which is required in the case of conventional models.

WHEN FLUORESCENT CALIBRATION IS NOT PERFORMED:

The UV full xenon lamp of the CM-3600d has a spectral distribution similar to that of the D65 light source. Therefore, when high accuracy fluorescent measurements are not required normal measurement of reflectance can be used to measure fluorescent reflectance.

UV CUT LIGHT SOURCES

With the CM-3600d, UV400 cut light source (with radiation at wavelengths of 390nm or lower eliminated) and UV420 cut light source (with radiation at wavelengths of 410nm or lower eliminated) are provided.

Dimensions

(mm)

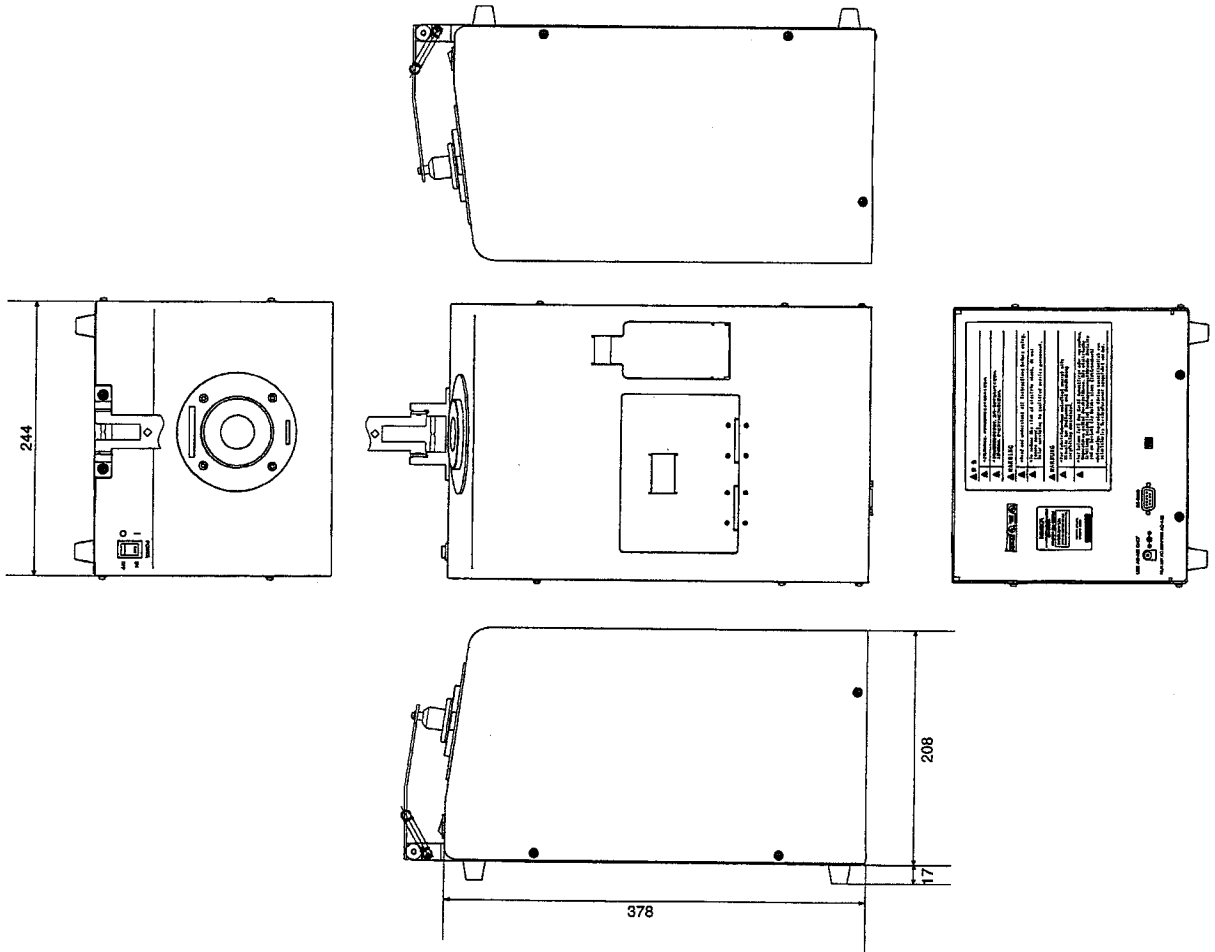

Specifications

Model	CM-3600d
Illumination/viewing system	Reflectance: d/8 (diffused illumination, 8-degree viewing), equipped with simultaneous measurement of SCI (specular component included)/SCE (specular component excluded). Conforms to CIE No. 15, ISO 7724/1, ASTM E1164, DIN 5033 Teil 7, and JIS Z 8722 Condition C standard. Transmittance: d/0 (diffused illumination, 0-degree viewing) Conforms to CIE No. 15, ASTM E1164, and DIN 5033 Teil 7 standards.
Light-receiving element	Silicon photodiode array (dual 40 elements)
Spectral separation device	Diffraction grating
Wavelength range	360nm to 740nm
Wavelength pitch	10nm
Half bandwidth	Approx. 10nm
Reflectance range	0 to 200%; resolution: 0.01%
Light source	Pulsed xenon lamps (× 4)
Measurement time	Approx. 1.5 seconds (for measurements of fluorescent colors, at 9600bps)
Minimum interval between measurements	Approx. 5 seconds
Measurement/illumination area	LAV: $\varnothing 25.4\text{mm}/\varnothing 30\text{mm}$ MAV: $\varnothing 8\text{mm}/\varnothing 11\text{mm}$ SAV: $\varnothing 4\text{mm}/\varnothing 7\text{mm}$ (Selectable)
Inter instrument agreement	Mean ΔE^*ab 0.15 (SCI) based on 12 BCRA Series II color tiles compared to values measured with master body.
Repeatability	Spectral reflectance: Standard deviation within 0.1% Colorimetric values: Standard deviation within ΔE^*ab 0.02 (when a white calibration plate is measured 30 times at 10-second intervals)
Temperature drift	Spectral reflectance: Within $\pm 0.10\%/^{\circ}\text{C}$ Color difference: Within ΔE^*ab 0.05/ $^{\circ}\text{C}$
UV adjustment	Instantaneous numerical adjustment
Transmittance chamber	Width: 133mm; depth: approx. 50mm; measurement dia.: approx. 17mm Transmission sample holder: Sample holder; for both plate-shaped and liquid samples (removable)
Control method	Directly connected to a computer
Interface	RS-232C Terminal : D-subminiature 9-pin (female) Baud rate : 1200, 2400, 4800, 9600, 19200bps Character bits : 8 bits Stop bit : 1 bit Parity check : None
Output data	Count, conditions, status
Other	Automatic delimiter code detection (during serial data communication)
Power	100-240Vac, 50-60Hz 25W AC (with a dedicated AC adapter)
Size (W × H × D)/weight	244 × 208 × 378mm (90-5/8 × 8-3/16 × 14-7/8 inch) 1.2Kg (2-5/8 lb).
Operation temperature/humidity range	13 to 33°C; less than 80% RH (at 33°C with no condensation); Altitude: 2000m or below; Installation category: 1; Pollution degree: 2
Storage temperature/humidity range	0 to 40°C, less than 80% RH (at 33°C with no condensation)
Standard accessories	White calibration plate CM-A103 Target mask ($\varnothing 4\text{mm}$) CM-A107 Target mask ($\varnothing 8\text{mm}$) CM-A106 Target mask ($\varnothing 25.4\text{mm}$) CM-A105 Zero calibration box CM-A104 AC adapter AC-A12 RS-232C cable (for NEC, 2m) IF-A12 Accessory Case CM-A109 Dust Cover CM-A110

- Specifications subject to change without notice.

MEMO

Minolta Camera Co., Ltd.

Minolta Camera Handelsgesellschaft m.b.H.

Minolta France S.A.

Minolta (UK) Limited

Minolta Austria Gesellschaft m.b.H.

Minolta Camera Benelux B.V.

Belgium Branch

Minolta (Schweiz) AG

Minolta Svenska AB

Minolta Corporation

Head Office (Meter Div.)

Minolta Canada Inc.

Head Office

Minolta Hong Kong Limited

Minolta Singapore (Pte) Ltd.

3-13, 2-Chome, Azuchi-Machi, Chuo-Ku, Osaka 541, Japan

Kurt-Fischer-Strasse 50, D-2070 Ahrensburg, West Germany Phone: 04102-70-1

357 bis, rue d'Estienne d'Orves, 92700 Colombes, France

1-3 Tanners Drive, Blakelands North, Milton Keynes, MK 14 5BU, England

Amalienstraße 59-61, 1131 Wien, Austria

Zonnebaan 39, 3606 CH Maarssenbroek, P.B. 264, 3600 AG Maarssen,
The Netherlands

Stenen Brug 115 – 117, 2200 Antwerpen, Belgium

Riedhof V, Riedstrasse 6, 8953 Dietikon-Zürich, Switzerland

Brännkyrkagatan 64, Box 17074, S-10462 Stockholm 17, Sweden

101 Williams Drive, Ramsey, New Jersey 07446, U.S.A. Phone: 201-825-4000

369 Britannia Road East, Mississauga, Ontario L4Z 2H5, Canada

Oriental Centre Ground Floor, 67-71 Chatham Road South,

Kowloon, Hong Kong Phone: 3-676051~6

10, Teban Gardens Crescent, Singapore 2260 Phone: 563-5533

Through The Years & Around The World: A CED Sponsored Learning Fair Providing Age-Specific & Culturally Competent Care at St. Joseph's



Enhancing Jobs & Advancing Education

At St. Joseph's we care for patients of all ages (from neonates to geriatrics) and many different cultures. With this comes the need for all direct care providers to be knowledgeable and skillful (or as JCAHO would say...competent) about differences in the care of patients of varying ages & cultures. How do we assess a 3 year-old differently from a 12 year-old? How do we insert a peripheral IV in an 85 year-old compared to a 35 year-old? How best to teach a 10-year old about their asthma medication? How to communicate effectively with a patient or colleague from another country?

Directions: Review each station with content related to your job at St. Joseph's. Note that you might not provide care to all ages of patients. Complete the educational activity (fishbowl question, post-test, etc.) then have the educator at the station sign the checklist. Have fun learning about the great ways we care for patients at St. Joseph's.

TOPIC	DATE COMPLETED	INSTRUCTOR SIGNATURE
GROWTH & DEVELOPMENT		
Erickson's Developmental Tasks; Developmental Stages		
AGE-SPECIFIC COMMUNITY RESOURCES FOR DISCHARGE PREPARATION & TEACHING		
Culturally Competent & Age-specific Patient Education, Identifying Community Resources, Identification & Reporting of Abuse: elder, child, domestic violence		
INFANT, TODDLER, PRE-SCHOOL, SCHOOL-AGE & ADOLESCENT		
Assessing Age-specific Clinical Data, Performing Age-specific Treatments, Age-appropriate Communication/interactive Skills, Involvement of Family &/or Significant Other In Plan of Care		
ADULT		
Assessing Age-specific Clinical Data, Performing Age-specific Treatments, Age-appropriate Communication/interactive Skills, Involvement of Family &/or Significant Other In Plan of Care		
GERIATRIC		
Assessing Age-specific Clinical Data, Performing Age-specific Treatments, Age-appropriate Communication/interactive Skills, Involvement of Family &/or Significant Other In Plan of Care, Aging Sensitivity, Spirituality of Aging		
PHARMACY SERVICES		
Drug Therapy in the Elderly; Pediatric Medication Administration		
CULTURALLY COMPETENT CARE		
Definitions of Culturally Competent Care, Dimensions of Culture, Behavioral Health Cultural Competence PI Team, Working With An Interpreter, Pastoral Care Resources		

Once you have completed all stations, share 1 example of how you have recently provided age-specific & culturally competent care on the easels by the stage & participate in the free raffle!

Learner Signature: _____ **Job Title** _____ **Date:** _____

PLEASE GIVE THIS RECORD TO YOUR SUPERVISOR. **Department** _____